



USER MANUAL

BEAM BAR 12

Notice
AVOID EYE OR SKIN EXPOSURE
TO DIRECT OR SCATTERED LIGHT
CLASS 4 LASER PRODUCT

Classified per IEC 60825-1: 2014
Complies with US FDA CDHR laser safety
standards 21 CFR 1040.10 & 1040.11
and Laser notice 56

CONTENTS

INTRODUCTION	3
PRODUCT LIST	3
PACKAGING	3
SAFETY NOTES	4
SAFETY LABEL LOCATION	5
PRODUCT SAFETY LABEL	5
TECHNICAL SPECIFICATION	6
BACK PANEL VIEW	7
DIMENSIONS	7
DMX DEFINE	8
DMX CH1 GOBO	9
INSTALLATION	11
PROPER USAGE	12
E-STOP BOX 3.0	13
INTERLOCK & MA CONSOLE	14
MAINTENANCE	15
WARRANTY POLICY	15

INTRODUCTION

Thank you for purchasing this LIGHTSPACE product. To ensure proper operation, please read this manual carefully before using the product. It could help you avoid dangerous and hazardous situations which could lead to serious injury or property damage. The manufacturer and its distributors cannot be held responsible for any damages caused by improper use or misuse of this LIGHTSPAC laser system. The owner/user is fully responsible for using this product in accordance to laser safety regulations of the country or state where the system is being used. Keep this User Manual for future consultation. If you sell this product to another user, be sure that they also receive this document.

PRODUCT LIST

Open the flight case / carton box carefully unpack everything inside.

Ensure all parts are present and in good condition.

Do not use any equipment that appears to be damaged and contact your supplier.



Laser Projector (1PCS)



W4578 Connector (1PCS)



Power cord (1PCS)



Safety Key for Projector (2PCS)



Metal Safety Wire (1PCS)



E-STOP BOX (1PCS)
Y45 Connector (1PCS)
Safety Key (2PCS)

PACKAGING



Carton box



Flight case

SAFETY NOTES

WARNING! This projector is a Class 4 laser product. It must never be used for audience-scanning applications. The output beam of the projector must always be at least 3 meters above the floor in the audience. See the proper operation section for further information.

Please read the following notes carefully! They include important safety information about the installation, usage, and maintenance of this product.

1. Keep this User Manual for future consultation. If you sell this product to another user, be sure that they also receive this document.
2. Always make sure that the voltage of the outlet to which you are connecting this product is within the range stated on the decal or rear panel of the product.
3. Product is not designed for use outdoors in adverse weather conditions. To prevent risk of fire or shock, do not expose this product to rain or moisture.
4. Always install this product in a location with adequate ventilation, at least 20 in (50 cm) from adjacent surfaces. Be sure that no ventilation slots are blocked.
5. Always disconnect this product from the power source before cleaning it or replacing the fuse.
6. Make sure to replace the fuse with another of the same type and rating.
7. If mounting it overhead, always secure this product to a fastening device using a safety chain or cable.
8. In the event of a serious operating problem, stop using the projector immediately. Never try to repair the unit except in a controlled environment under trained supervision. Repairs carried out by unskilled people can lead to damage or malfunction of the unit, as well as exposure to dangerous laser light.
9. Never connect this product to a dimmer pack.
10. Make sure the power cord is not crimped or damaged.
11. Never disconnect the power cord by pulling or any moving part. Always use the hanging/mounting bracket or the handles. Or tugging on the cord.
12. Never carry a product from the power cord.
13. Always avoid eye or skin exposure to direct or scattered light from this product.
14. Lasers can be hazardous and have unique safety considerations. Permanent eye injury and blindness is possible if lasers are used incorrectly. Pay close attention to each safety REMARK and WARNING statement in this user manual. Read all instructions carefully BEFORE operating this device.
15. Never intentionally expose yourself or others to direct laser light.
16. This laser product can potentially cause instant eye injury or blindness if laser light directly strikes the eyes.
17. It is illegal and dangerous to shine this laser into audience areas, where the audience or other personnel could get direct laser beams or bright reflections into their eyes.
18. It is a US Federal offense to shine any laser at aircraft.
19. No service allowed by customer. There are no user serviceable parts inside the unit. Do not open the housing or attempt any repairs yourself. Service is only to be handled by the factory or authorized factory trained technicians
20. Product is not to be modified by the customer.
21. Caution use of controls or adjustments or performance of procedures other than those specified herein may result in hazardous radiation exposure.

SAFETY LABEL LOCATION

BEAM BAR 12

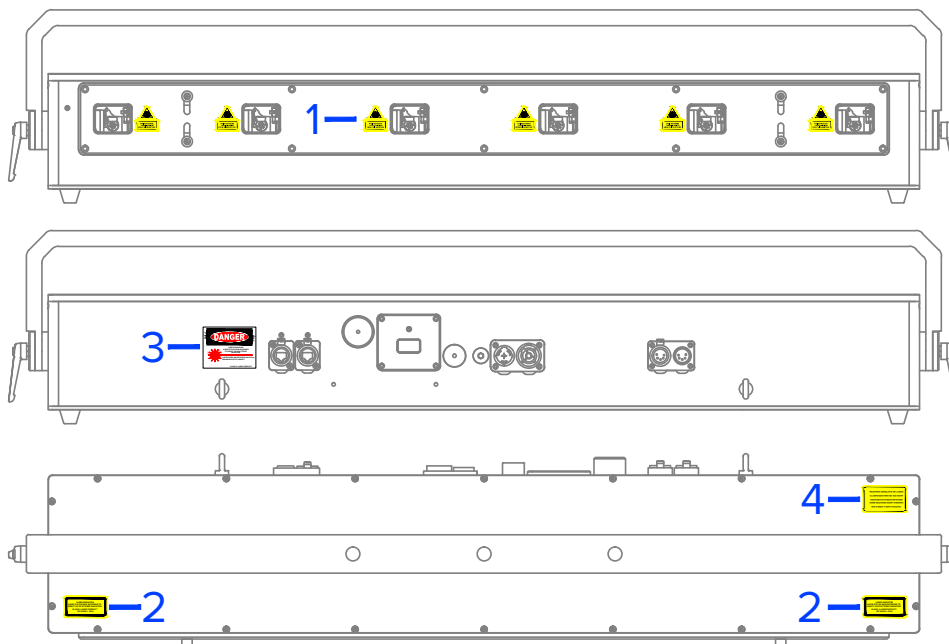

- 1. Harazd Warning Symbol
- 2.Explanatory Label
- 3.Danger Laser Radiation
- 4.Hazard Warning Mark

PRODUCT SAFETY LABEL



Harazd Warning Symbol



Explanatory Label

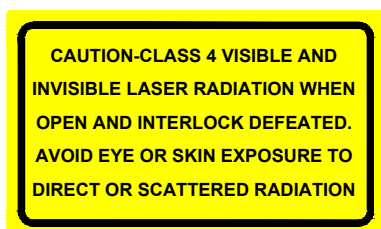

Danger Laser Radiation



Hazard Warning Mark

TECHNICAL SPECIFICATION

MODEL	BEAM BAR 12
Total laser power	≥13,200mW
Diode-638nm	600mW*6
Diode-525nm	800mW*6
Diode-445nm	800mW*6
Beam divergence	<1.4mrad [full angle]
Modulation	>100KHz
Modulation way	Linear analog modulation
Scanner type	PT-A40M
Scanning system	30Kpps@8°
Scan angle	45 degree
Signal connector	ArtNet,DMX,ILDA control
Ingress rating	IP65
Temperature control	Dual constant temperature system
Operating temperature	-10-40°C
Dimensions	Length:998 Width:181 Height:148
Weight	24 kg
Power requirements	100-240V 50-60Hz
Consumption	600W
E_{MPE}	10W · m ⁻²
Nohd	386m

BACK PANEL VIEW

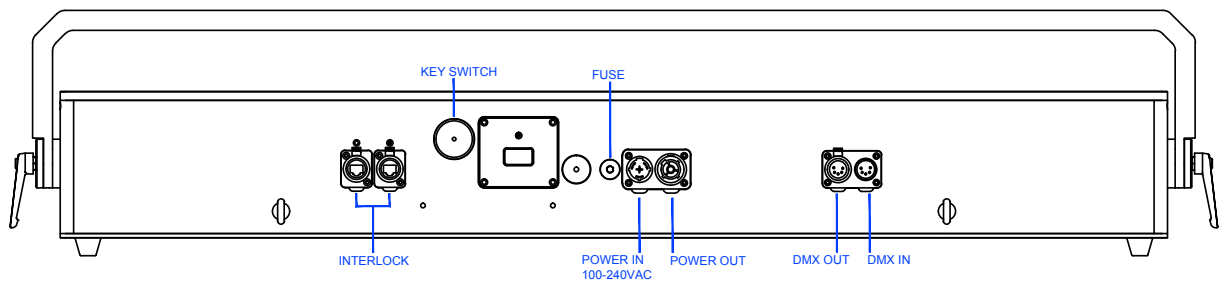

DIMENSIONS

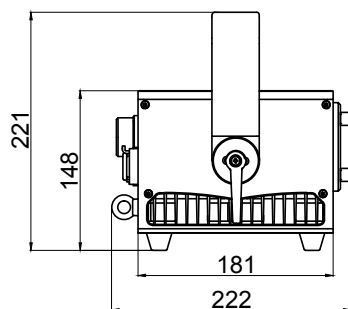
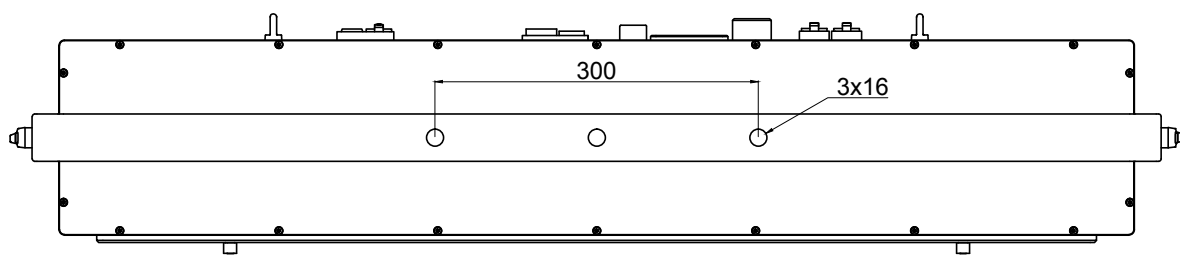
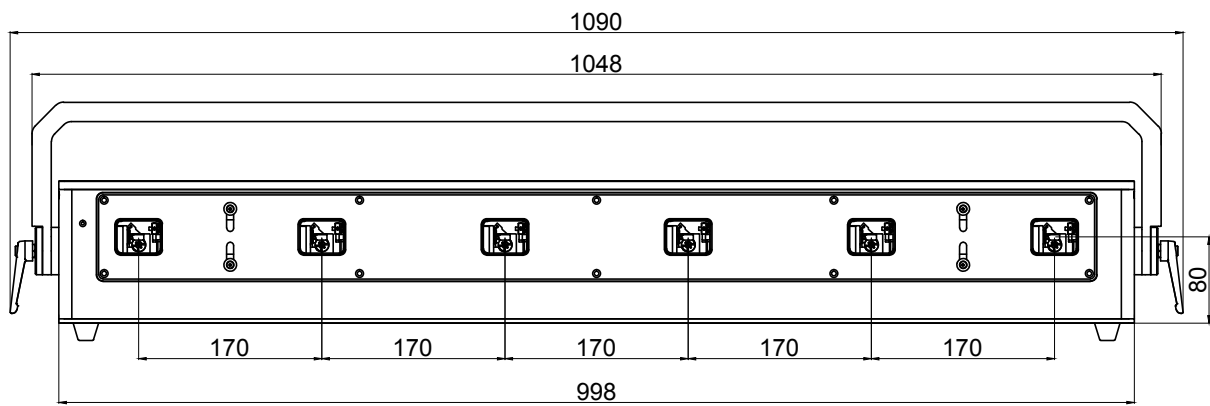









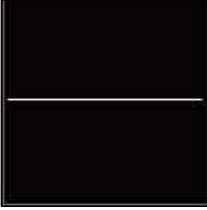
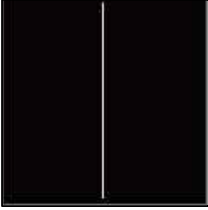

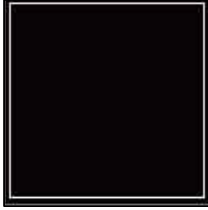
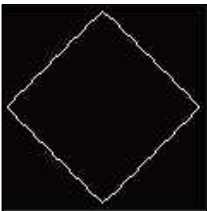
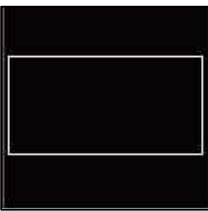
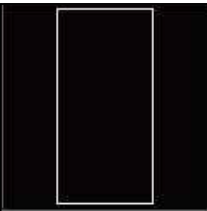

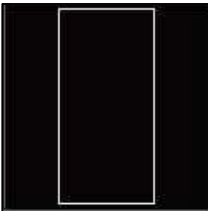
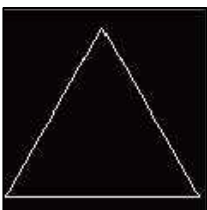
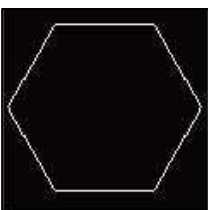
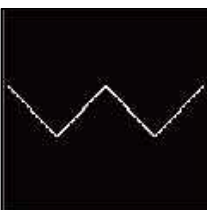
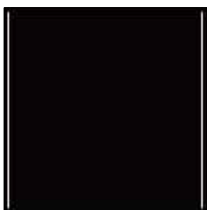

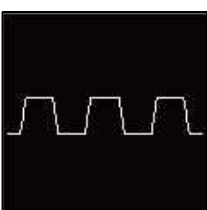

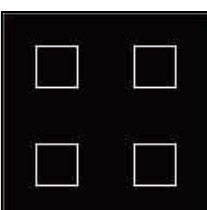
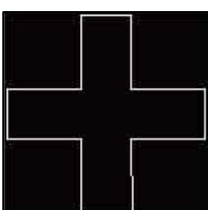
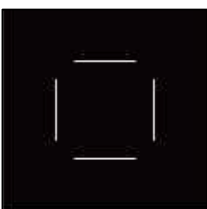
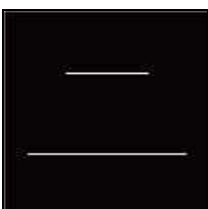
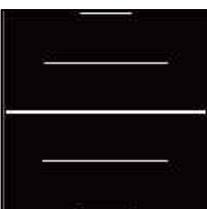

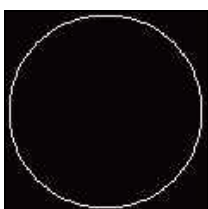

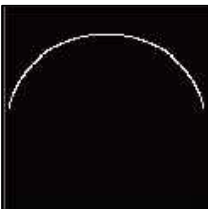
DMX DEFINE

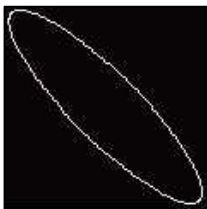
26CH DMX PROFILE ASSIGNMENT(one output)					
CH	NAME	8/16bit	Description	Default	Remark
CH1	Cues/gobos	8bit	0 = No output, 1 - 57 = cue 1 - 57, 58 - 255 = No output	0	
CH2	Cue speed	8bit	0 = 0%, 100 = 100%, 255 = 255%	100	Reserve
CH3	Beam	8bit	0 = Normal, 1 - 255 = Point 33 ~ 2	0	
CH4	Dimmer	8bit	0 = 0%, 255 = 100%	0	
CH5,6	Zoom	16bit	0 = -100%, 32768 = 0, 65535 = +100%	65535	
CH7,8	X size	16bit	0 = -100%, 32768 = 0, 65535 = +100%	65535	
CH9,10	Y size	16bit	0 = -100%, 32768 = 0, 65535 = +100%	65535	
CH11,12	Z angle	16bit	0 = 0°, 65535 = 360°	0	
CH13,14	Z rotation	16bit	Continues rotation from -60 till 60 Rpm, 0 = Original, 1 till 32767 = -100% till -1% rotation, 32768 = keep angle but do not rotate, 32769 till 65535 = 1% till 100% rotation	32768	
CH15,16	X position	16bit	0 = -100%, 32768 = 0, 65535 = +100%	32768	
CH17,18	Y position	16bit	0 = -100%, 32768 = 0, 65535 = +100%	32768	
CH19	Scanrate	8bit	0-255 = From 5k ~ 25k	255	
CH20	Red	8bit	Red component for mixing with the original cue	255	
CH21	Green	8bit	Green component for mixing with the original cue	255	
CH22	Blue	8bit	Blue component for mixing with the original cue	255	
CH23	Alpha	8bit	0 - 31 = Original color, 32 - 223 = RGB color, 224 - 255 = White	0	
CH24	Visible points start	8bit	Cut off points from the start of a frame	0	
CH25	Visible points end	8bit	Cut off points from the end of a frame	255	
CH26	Strobe	8bit	0 = Off, 1 = 1Hz , 255 = 20Hz	0	

Note: The laser enabling channel is 1CH, this channel controls the enabling of 6 groups of lasers; This channel cannot be changed, but it can be overlapped and must be set, channel value 0= off output ,1-255= Enable laser.

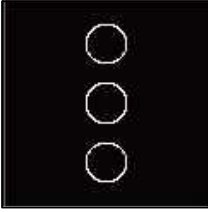
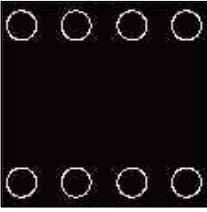
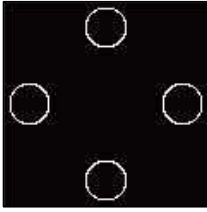
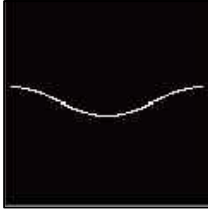
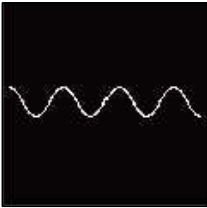
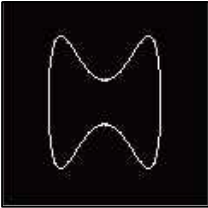
DMX CH1 GOBO

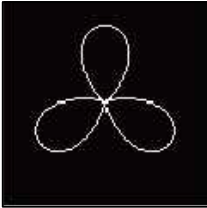
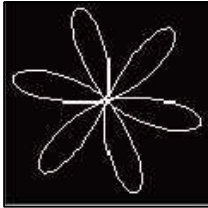
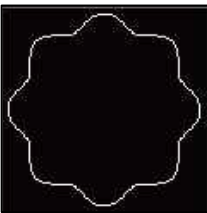
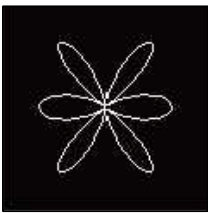
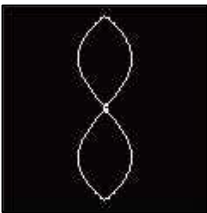
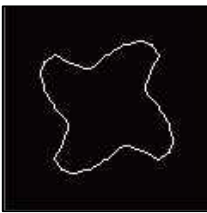
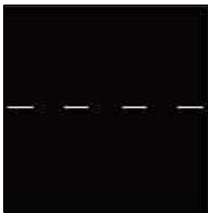
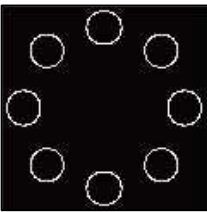
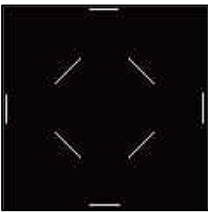
DMX CHANNEL 1 GOBO				
Cue 1 	Cue 2 	Cue 3 	Cue 4 	Cue 5 
DMX Value 001	002	003	004	005
Cue 6 	Cue 7 	Cue 8 	Cue 9 	Cue 10 
DMX Value 006	007	008	009	010
Cue 11 	Cue 12 	Cue 13 	Cue 14 	Cue 15 
DMX Value 011	012	013	014	015
Cue 16 	Cue 17 	Cue 18 	Cue 19 	Cue 20 
DMX Value 016	017	018	019	020
Cue 21 	Cue 22 	Cue 23 	Cue 24 	Cue 25 
DMX Value 021	022	023	024	025
Cue 26 	Cue 27 	Cue 28 	Cue 29 	Cue 30 
DMX Value 026	027	028	029	030

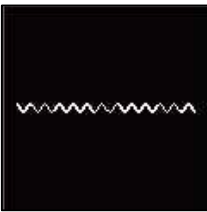
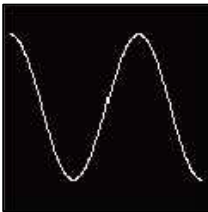
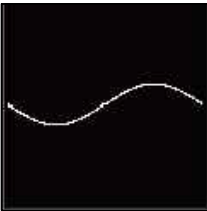
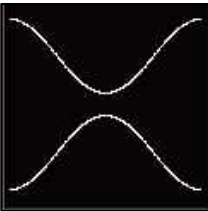
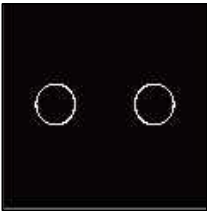
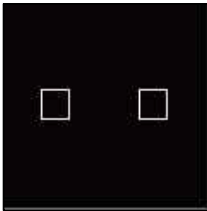
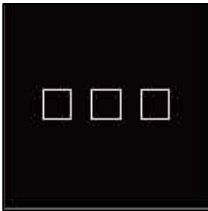
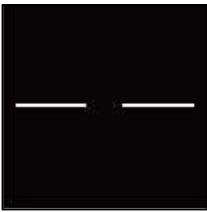
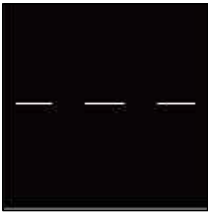
DMX CHANNEL 1 GOBO				
<p>Cue 31</p> 	<p>Cue 32</p> 	<p>Cue 33</p> 	<p>Cue 34</p> 	<p>Cue 35</p> 
DMX Value 031	032	033	034	035
<p>Cue 36</p> 	<p>Cue 37</p> 	<p>Cue 38</p> 	<p>Cue 39</p> 	<p>Cue 40</p> 
DMX Value 036	037	038	039	040
<p>Cue 41</p> 	<p>Cue 42</p> 	<p>Cue 43</p> 	<p>Cue 44</p> 	<p>Cue 45</p> 
DMX Value 041	042	043	044	045
<p>Cue 46</p> 	<p>Cue 47</p> 	<p>Cue 48</p> 	<p>Cue 49</p> 	<p>Cue 50</p> 
DMX Value 046	047	048	049	050
<p>Cue 51</p> 	<p>Cue 52</p> 	<p>Cue 53</p> 	<p>Cue 54</p> 	<p>Cue 55</p> 
DMX Value 051	052	053	054	055
<p>Cue 56</p> 	<p>Cue 57</p> 	Reserved		
DMX Value 056	057	058-255		

INSTALLATION

Please follow the below rules during installation

1. The owner/user is fully responsible for using this product in accordance to laser safety regulations of the country or state where the system is being used.
2. If mounting it overhead, always secure this product to a fastening device using a safety chain or cable.
3. Be sure that the structure onto which you are mounting this product can support its weight.
4. Always consider ease of access to the unit before deciding on a location for this product.
5. Always disconnect this product from the power source during installation.
6. Make sure the power cord is not crimped or damaged.
7. Install the product only at a firm, secure and accessible installation point away from unauthorized persons.
8. Make sure the product is properly tightened and does not break down due to sound vibrations, cable tension, or others.
9. Always make sure that the voltage of the outlet to which you are connecting this product is within the range stated on the decal or rear panel of the product.
10. Make sure the laser is placed at least 50cm away from walls or other place (including curtains, etc.).
11. Make sure the laser is away from any heat source, including spotlights, headlights, radiators, and make sure there is enough flowair for it.
12. Mount the product securely. You can do this with a screw, a nut, and a bolt. You may also use a mounting clamp if rigging this product onto a truss. The U-shaped support bracket has three mounting holes which may be used to secure the clamps to the projector.
13. Be sure that the structure onto which you are mounting this product can support its weight more than 10 times.
14. Make sure do not block the fan outlet when operating the laser.

The manufacturer and its distributors cannot be held responsible for any damages caused by improper use or misuse of this LIGHTSPACE laser system.

PROPER USAGE

Caution - use of controls or adjustments or performance of procedures other than those specified herein may result in hazardous radiation exposure.

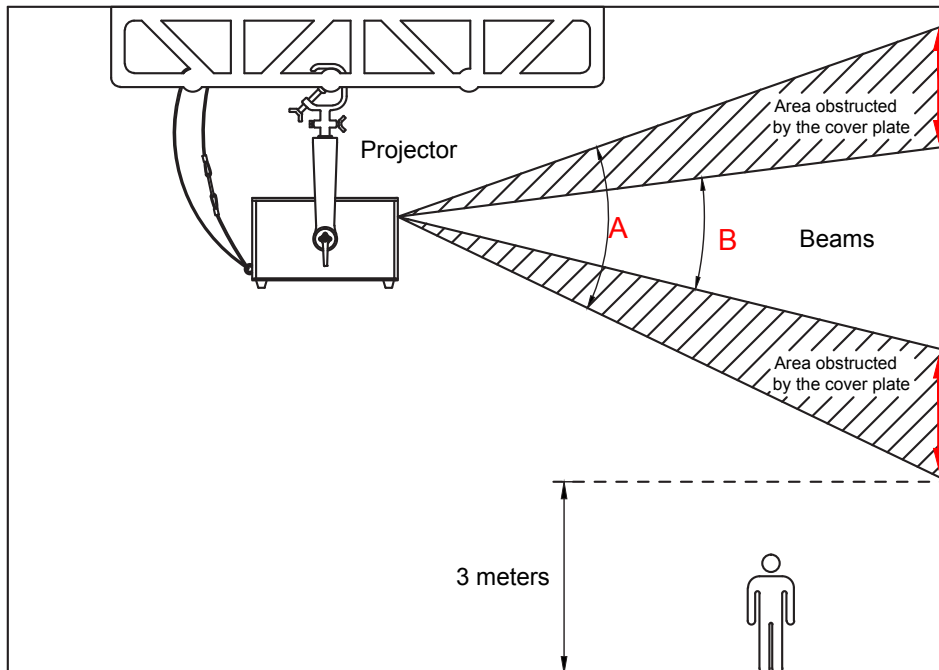

The audience area can be passively protected by sliding the aperture cover plate upwards and fixing it in proper position by the thumb screws.

A

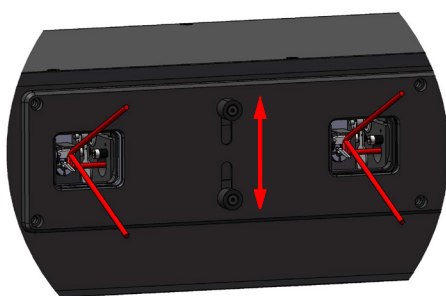

B

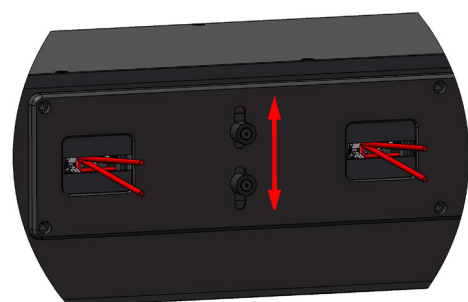

This product is for overhead mounting only. For safety purposes, this projector should be mounted on steady elevated platforms or sturdy overhead supports using suitable hanging clamps. In all cases, you must use safety cables.

International laser safety regulations require that laser products must be operated in the fashion illustrated below, with a minimum of 3 meters (9.8 ft) of vertical separation between the floor and the lowest laser light vertically. Additionally, 3 meters of horizontal separation is required between laser light and audience or other public spaces.

E-STOP BOX 3.0

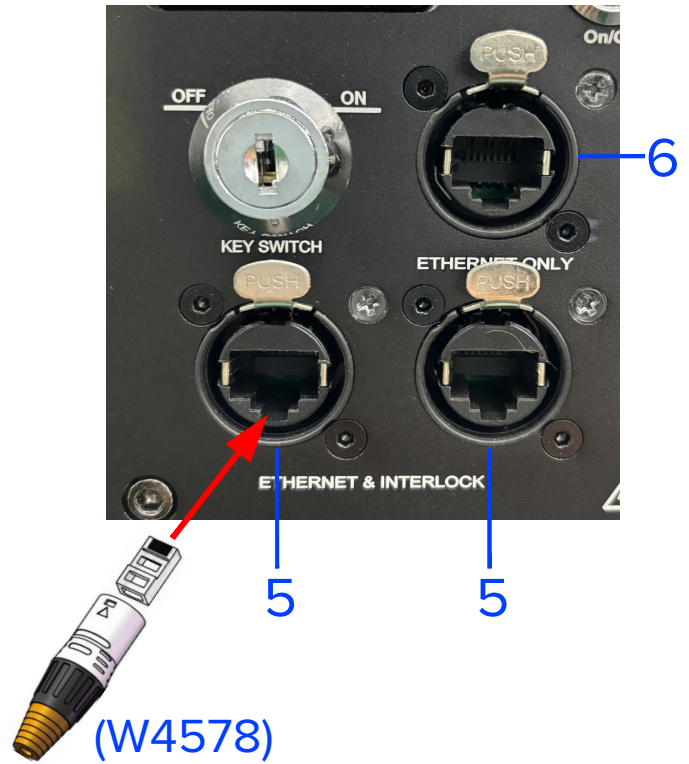
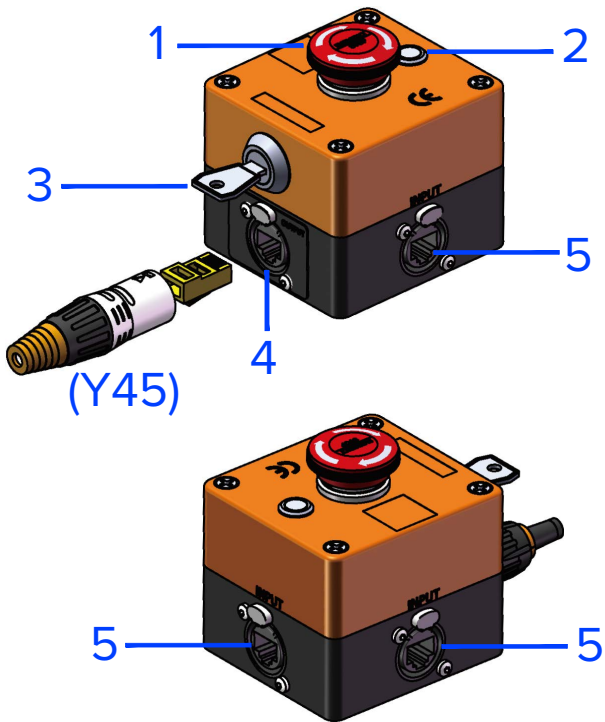

NO.	Name	Function
1	E-STOP SWITCH	Press the E-STOP SWITCH,the projector shut off immediately.
2	RE-START	Press the RE-START,the projector re-start and begin emitting laser light.
3	KEY SWITCH	Remote interlock box lock
4	Y45 PORT	PIN4 and PIN5, Use for NEXT E-STOP
5	W4578 PORT	PIN4 and PIN5 Use for E-STOP SWICH and KEY SWICH PIN7 and PIN8 use for RE-START PIN1,PIN2,PIN3 and PIN6 use for ETHERNET
6	ETHERNET	PIN1,PIN2,PIN3 and PIN6 use for ETHERNET PIN4,PIN5,PIN7 and PIN8 no use or unknown

W4578:
Convenient for internal inspection, instead of E-STOP
(PIN4 and PIN5 connect together
PIN7 and PIN8 connect together)

Y45:
Convenient for internal inspection, instead of NEXT
E-STOP (PIN4 and PIN5 connect together)

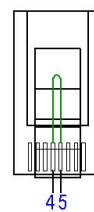
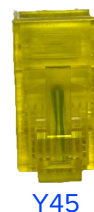
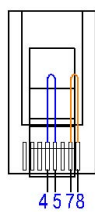

INTERLOCK & MA CONSOLE

REMOTE INTERLOCK

1. Proper using remote interlock,E-stop,refer to below.
2. Connect the remote E-stop box to any of the RJ45 connector on the rear of the projector using Ethernet cable. Ensure that the other end of the cable is firmly attached to the E-stop box.
3. If you do not use E-stop box, please insert the W4578 Connector to the projector.

Please pay attention! In most of countries, every laser system is required by law to have a fully functioning emergency stop switch.If you use the provided interlock connector instead of the safety interlock, you must have another way to stop the laser output immediately in case of emergency.

INTERLOCK / MA CONSOLE

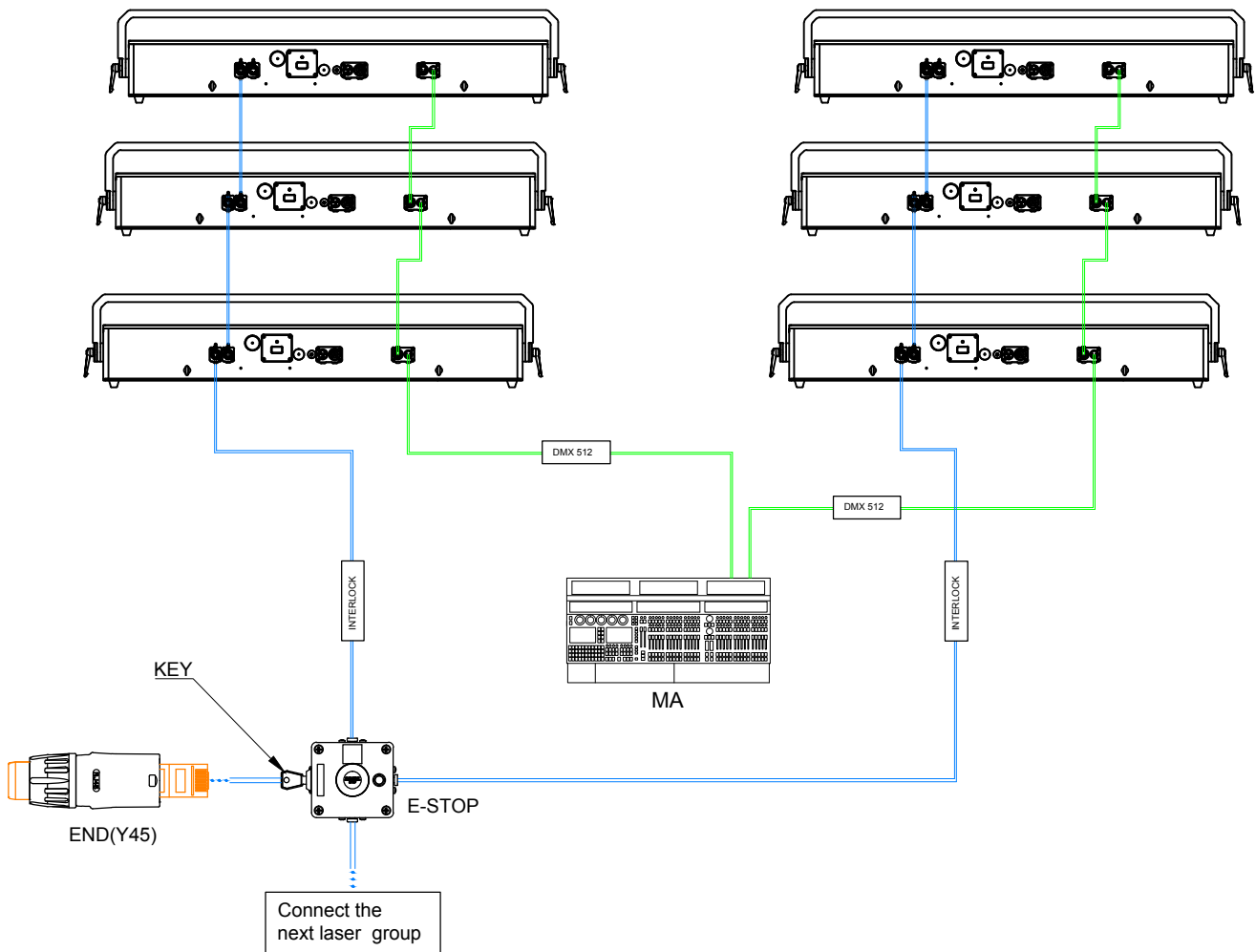

MAINTENANCE

1. Always disconnect this product from the power source before cleaning it or replacing the fuse.
2. Cleaning of internal optical elements must be done by authorized technicians. Improper operation or chemical for cleaning can cause serious damage to the projector. Cleaning times depend on the operating times and operating environment. It is recommended to clean the external optical system every 180 days.
3. Check regularly for loose screws and damaged parts. Replace damaged parts if necessary.
4. Added regularly to various rotating parts or bearings to improve the lifespan of the products.
5. Make sure to replace the fuse with another of the same type and rating.
6. In the event of a serious operating problem, stop using the projector immediately. Never try to repair the unit except in a controlled environment under trained supervision. Repairs carried out by unskilled people can lead to damage or malfunction of the unit, as well as exposure to dangerous laser light.
7. No service allowed by customer. There are no user serviceable parts inside the unit. Do not open the housing or attempt any repairs yourself. Service is only to be handled by the factory or authorized factory trained technicians.

WARRANTY POLICY

1. The laser projector from LIGHTSPACE has two years warranty service (from the date of purchase), when applying for warranty, need to show warranty card and original purchase voucher.
2. During the warranty period, LIGHTSPACE will provide free maintenance for customers, but for out of warranty, customers would need to bear repair cost.
3. Stop using immediately and contact your supplier if you found the projector is over heating, damaged or other abnormal situation.
4. The warranty service is not including following situations: Injury caused by accident or improperly use; The component isn't from LIGHTSPACE; To modify product without any approval of LIGHTSPACE.
5. For any maintenance problems, please dial the official service E-mail : **service@8lightspace.com**
6. The right of final explanation belongs to LIGHTSPACE.

